

Baggy

Paola Navone - OTTO Studio



TA



TA TRIO



FL TRIO



SO HORIZONTAL



SO VERTICAL



Baggy è una collezione eclettica di lampade dal mood informale e giocoso, come i pantaloni oversize che ne ispirano il nome.

Le lampade Baggy sono disponibili come moduli singoli di diverse dimensioni che consentono una totale libertà di composizione.

La sospensione verticale Baggy ha un diffusore in policarbonato bisatinato dall'aspetto irregolare, come fosse un tubo di carta stropicciato, mentre il rosone è nella finitura laccato bianco opaco.

La caratteristica corda tessile morbida bianco/grigio – dettaglio che esprime la cifra stilistica archi-decorativa del brand – sorregge la lampada nella versione a sospensione orizzontale e diventa elemento di raccordo per le varianti da tavolo e da terra. Ciò che rende speciale Baggy è la forma organica, contenente un LED personalizzato che emette luce in modo magico e inaspettato.

Baggy is an eclectic collection of lamps with an informal and playful mood, like the oversized trousers that inspire its name.

Baggy lamps are available as individual modules of different sizes that allow total freedom of composition.

The Baggy vertical suspension lamp has a double-satin polycarbonate diffuser with the irregular appearance of a crumpled paper tube, while the ceiling rose is in matt white lacquered finish. The distinctive soft textile cord in white/grey – a detail that expresses the brand's archi-decorative stylistic code – supports the lamp in the horizontal suspension version and becomes a joining element for the table and floor variants. What makes Baggy special is the organic shape, containing a custom LED that emits light in a magical and unexpected way.

SPECIFICHE PRODOTTO / PRODUCT SPECIFICS

BAGGY TA SMALL
BAGGY TA MEDIUM
BAGGY TA TRIO

p.2

BAGGY FL TRIO

p.6

BAGGY SO ORIZZONTALE L.60
BAGGY SO ORIZZONTALE L.90

p.7

p.8

BAGGY SO VERTICALE H.60
BAGGY SO VERTICALE H.90

p.9

p.10

DIFFUSORE / DIFFUSER

Policarbonato bisatinato
Dual satin polycarbonate

CORDA / ROPE

Corda in tessuto color bianco/grigio
(no baggy so verticale)
*White/grey colour fabric rope
(no baggy so vertical)*

FONTE LUMINOSA / LIGHT SOURCE**220-240V**

Custom Strip LED

TA SMALL

1 x 10.5W Custom Strip LED
Emissione / Light emission: 1.085 Lm
IP20

TA MEDIUM / SO VERTICAL H.60

1 x 23W Custom Strip LED
Emissione / Light emission: 2.345 Lm
IP20

TA TRIO

1 x 54W Custom Strip LED
Emissione / Light emission: 5.590 Lm
IP20

FL TRIO

1 x 195W Custom Strip LED
Emissione / Light emission: 20.010 Lm
IP20

SO HORIZONTAL L.60

1 x 21W Custom Strip LED
Emissione / Light emission: 2.165 Lm
IP20

SO HORIZONTAL L.90 / VERTICAL H.90

1 x 36W Custom Strip LED
Emissione / Light emission: 3.605 Lm
IP20

Dimmerazione a taglio di fase/Triac -
altri sistemi di dimmerazione (DALI e 1-10V)
disponibili su richiesta

*Phase cut/Triac dimming -
alternative dimming systems
(DALI and 1-10V) available on demand*



Baggy

110V

Custom Strip LED

TA SMALL

1 x 10.5W Custom Strip LED
Light emission: 1.085 Lm
IP20

TA MEDIUM / SO VERTICAL H.60

1 x 23W Custom Strip LED
Light emission: 2.345 Lm
IP20

TA TRIO

1 x 54W Custom Strip LED
Light emission: 5.590 Lm
IP20

FL TRIO

1 x 195W Custom Strip LED
Light emission: 20.010 Lm
IP20

SO HORIZONTAL L.60

1 x 21W Custom Strip LED
Light emission: 2.165 Lm
IP20

SO HORIZONTAL L.90 / VERTICAL H.90

1 x 36W Custom Strip LED
Light emission: 3.605 Lm
IP20

Phase cut/Triac dimming -
alternative dimming systems
(DALI and 1-10V) available on demand

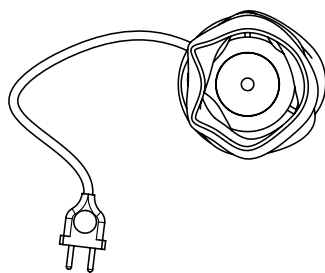
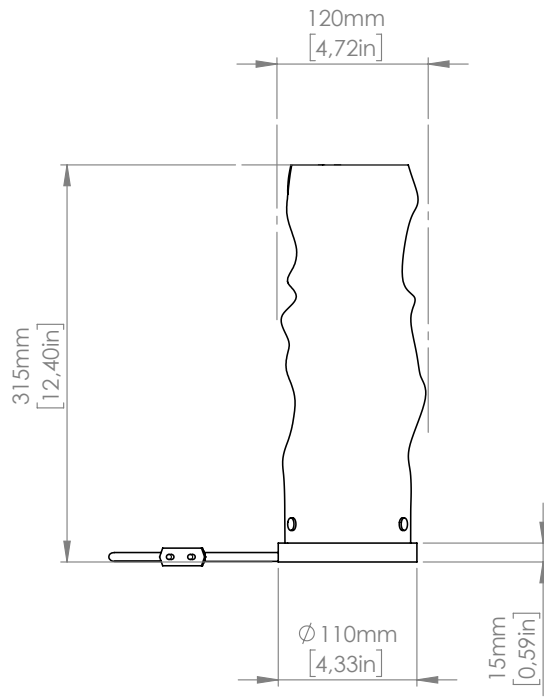

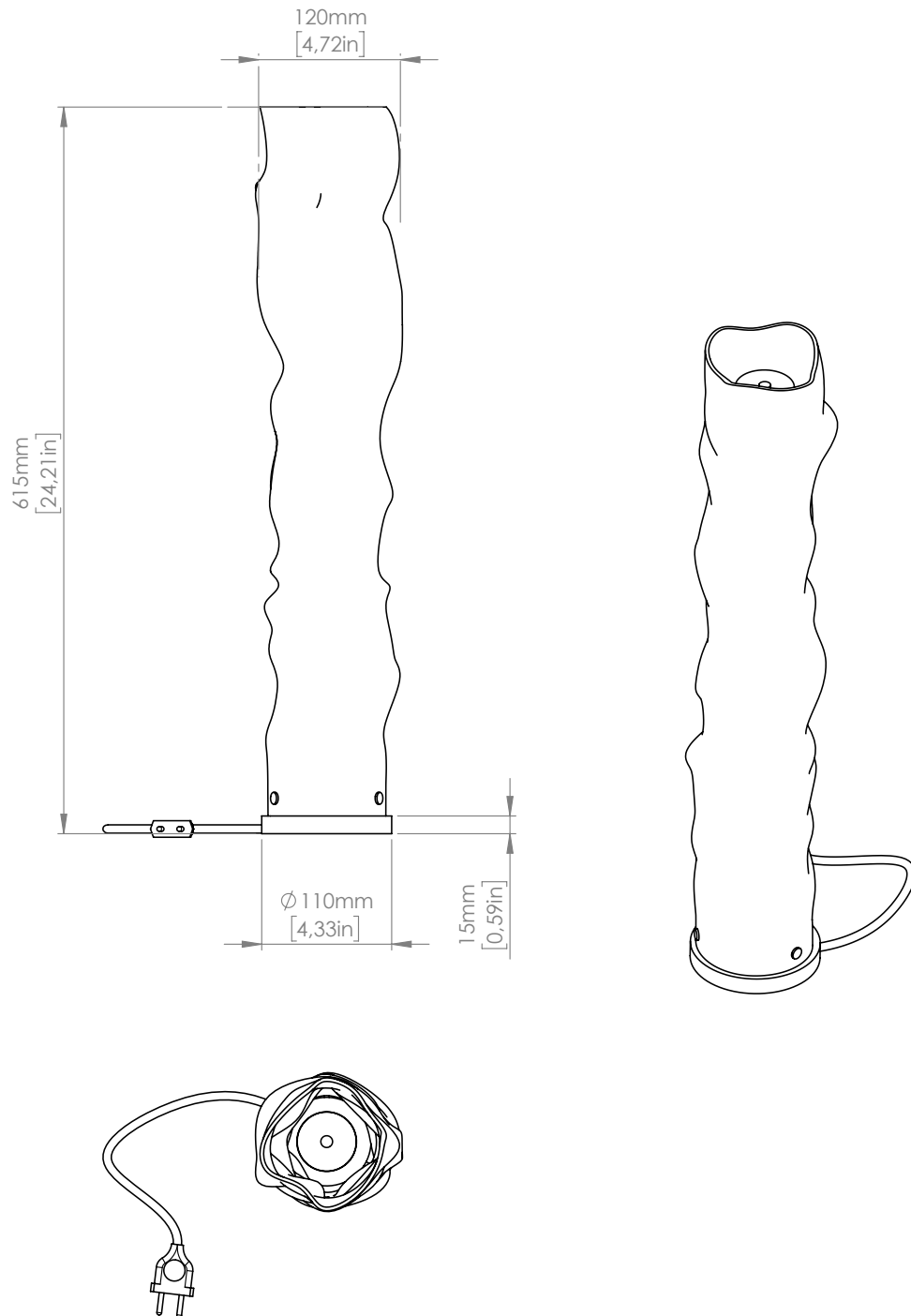

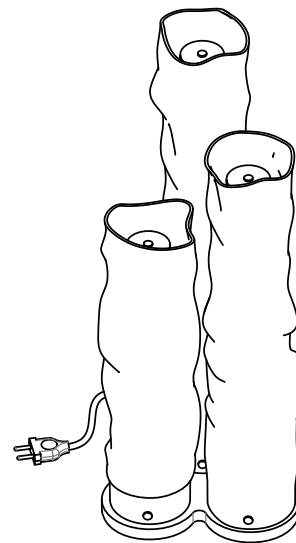
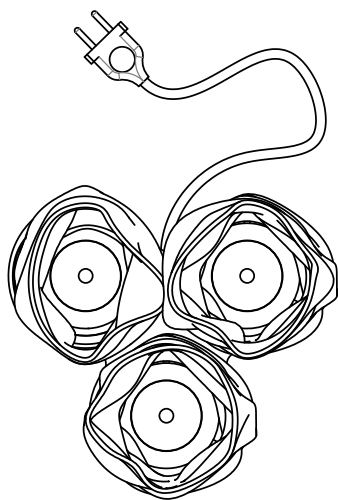
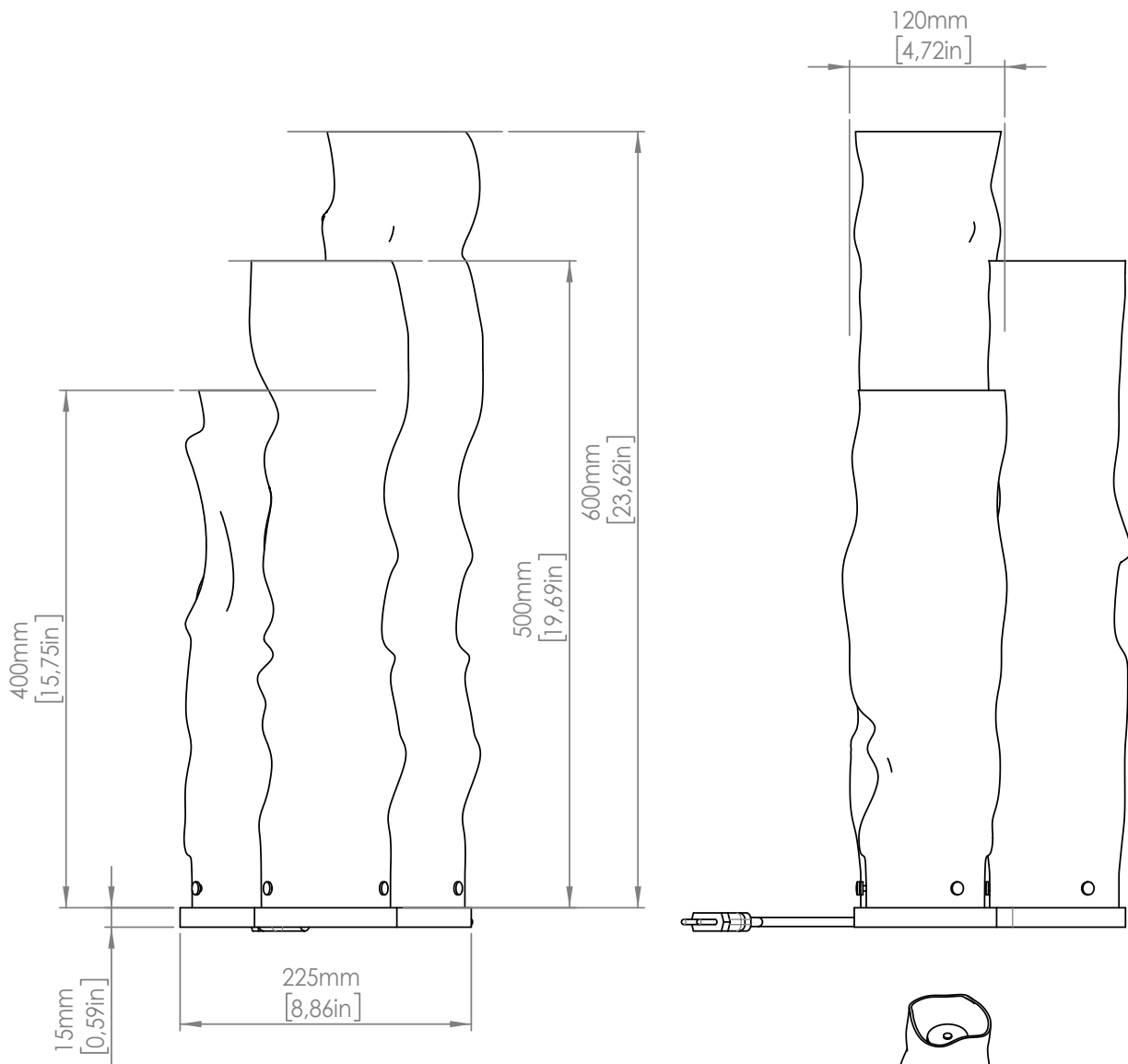

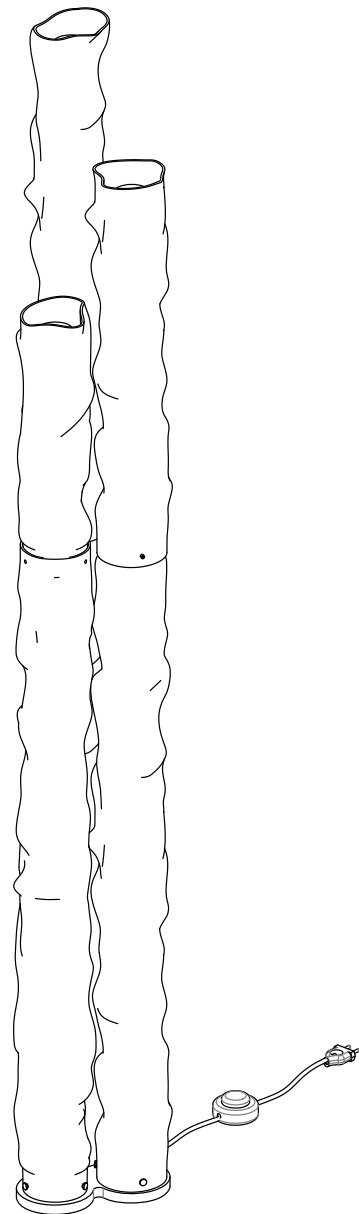
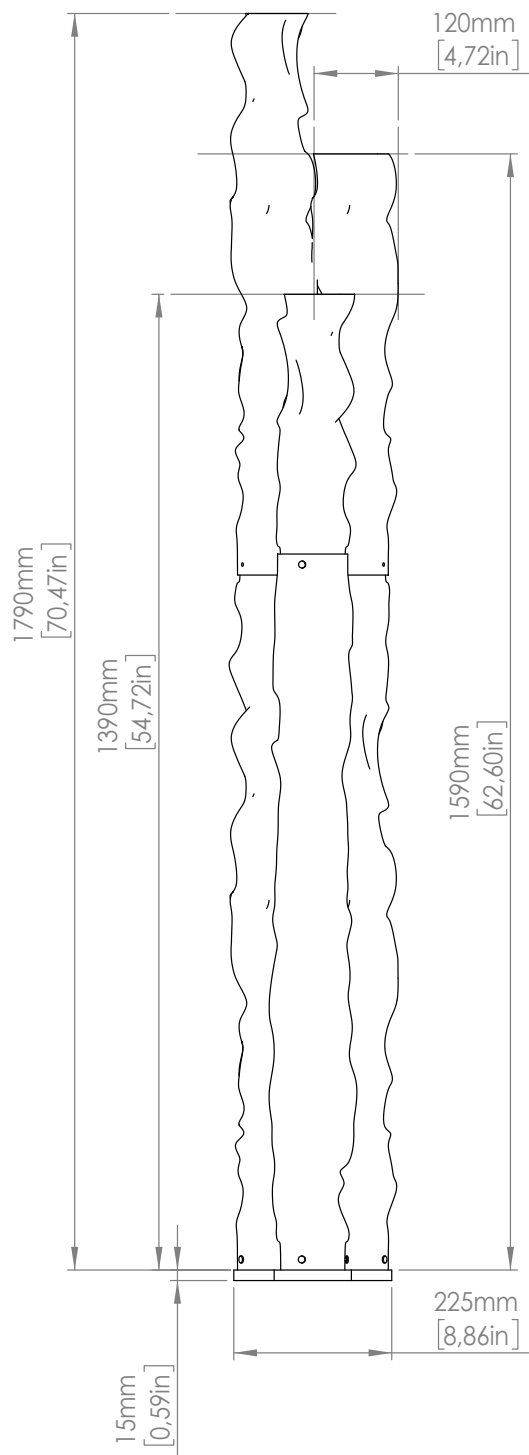

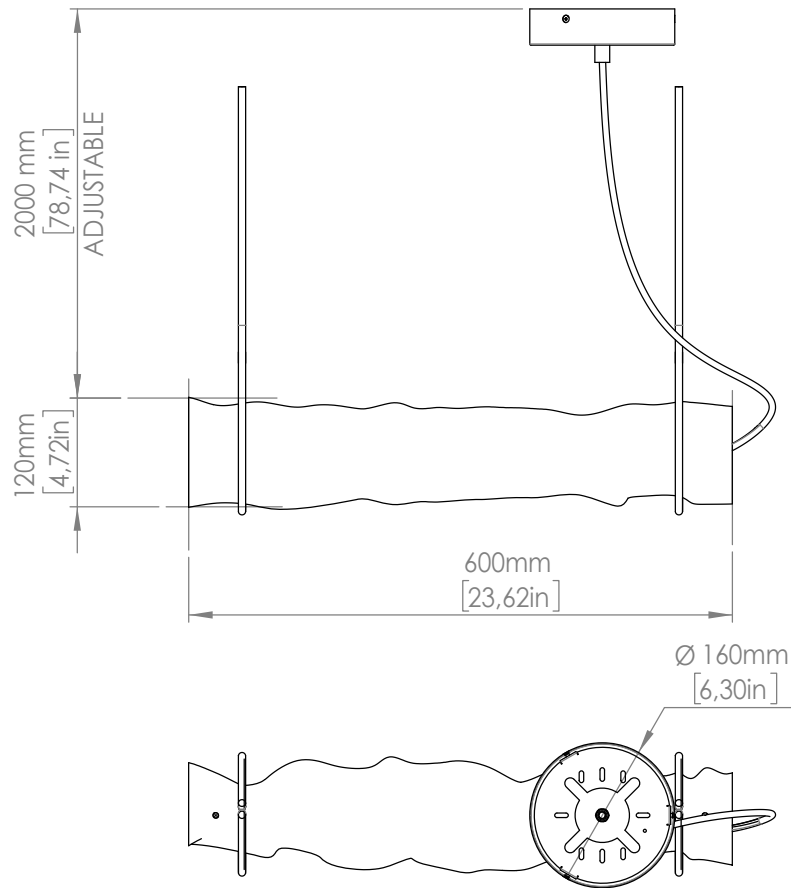

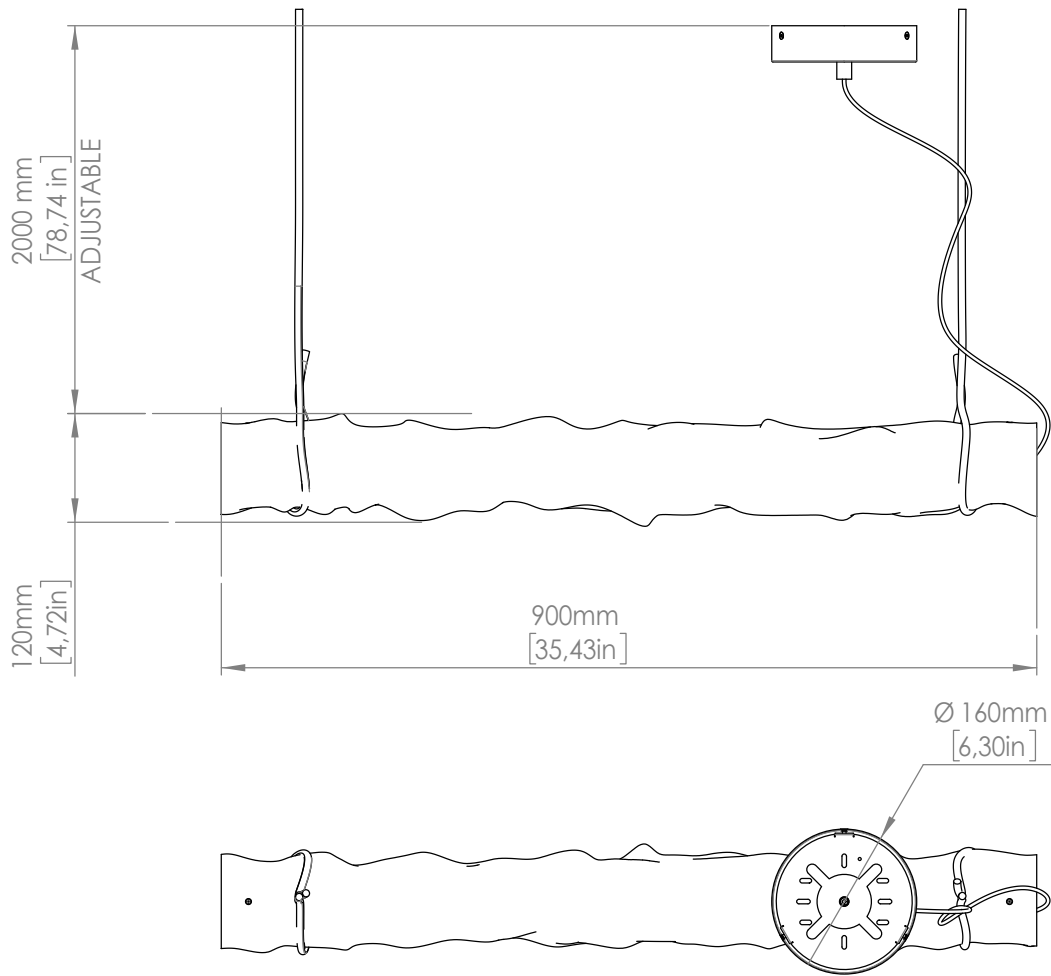

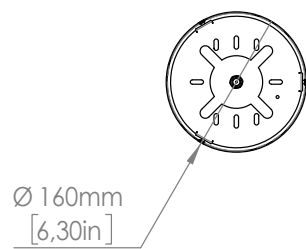
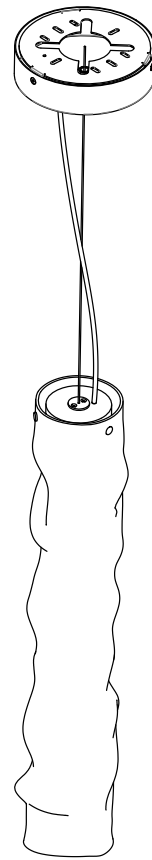
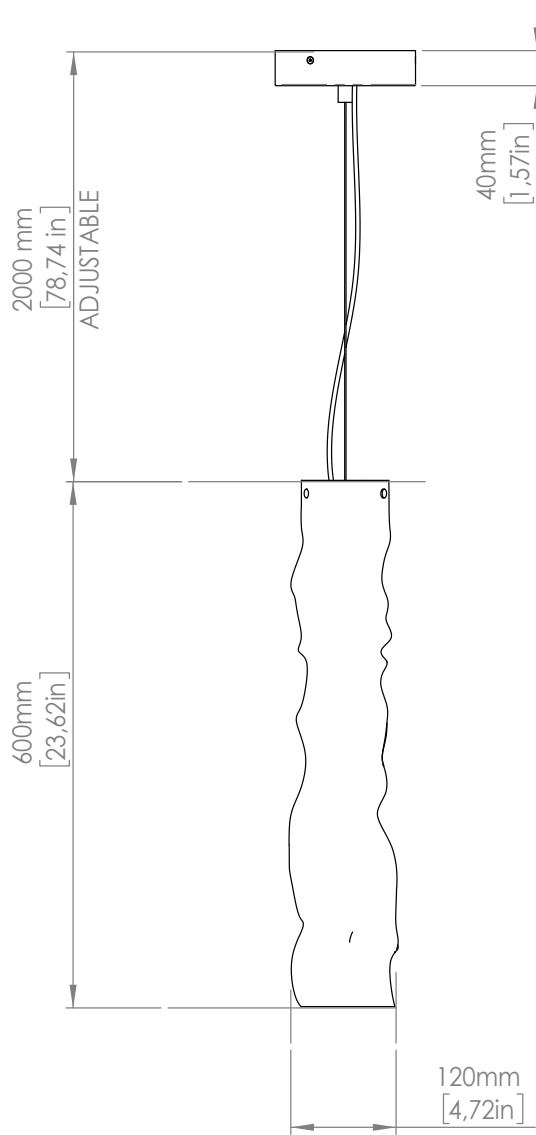

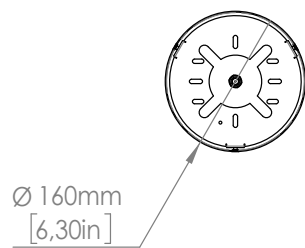
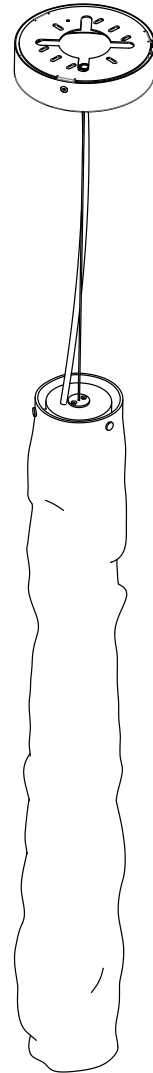
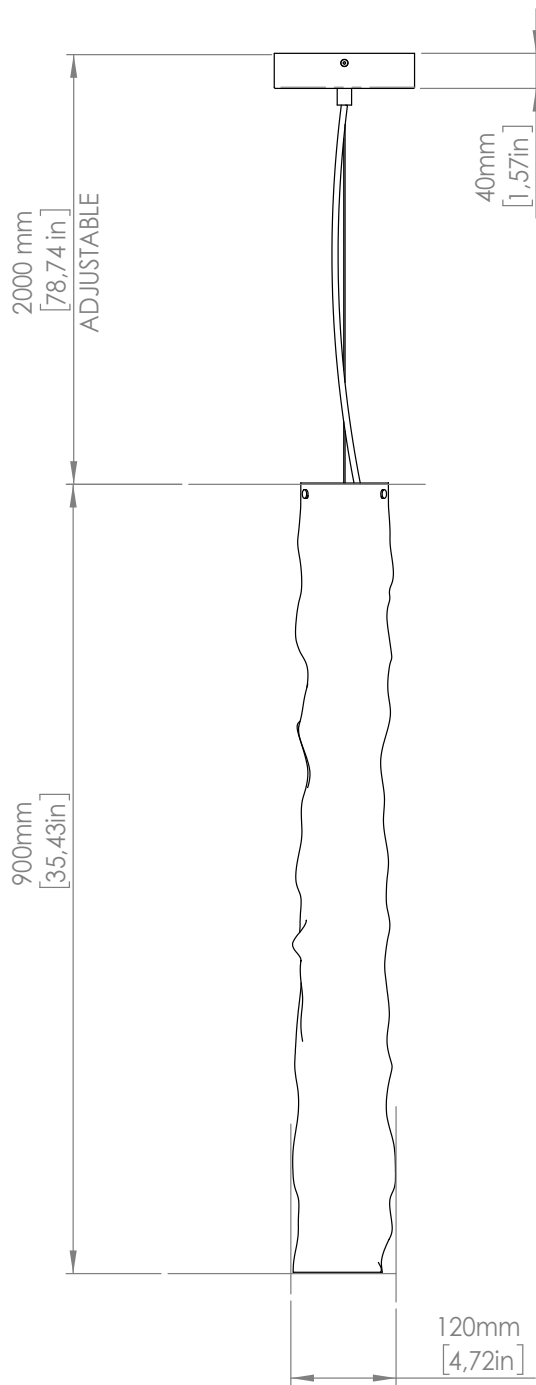

Copyright and/or design rights subsist in this drawing. No part of this drawing may be reproduced in any material form (including photocopying or storing in any medium electronic means, whether or not intentionally and whether or not as part or a larger publication) without the express permission of the copyright owner, Contardi Lighting S.r.l.. Further and without prejudice to the above, this drawing and all information relating thereto is confidential, and shall not be communicated to a third party without the consent of Contardi lighting srl. Contardi lighting srl asserts all rights to be identified as the author of the work and otherwise.

WARNING: The doing of any unauthorised act in relation to a copyright work may result in both a civil claim for damages and criminal prosecution.

CONTARDI LIGHTING Srl

ITALY HEADQUARTERS

contardi-italia.com / sales@contardi-italia.it

CONTARDI USA Inc

USA BRANCH

contardi-usa.com / office@contardi-usa.com