

ALL OPERATIONS MUST BE CARRIED OUT BY QUALIFIED PERSON

- ① Fix the bracket to the ceiling (use appropriate anchors depending on the type of wall).

Fissare la staffa al soffitto (utilizzare tasselli appropriati in relazione al tipo di soffitto).

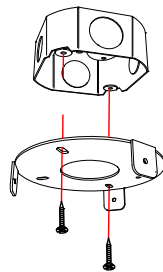

USA

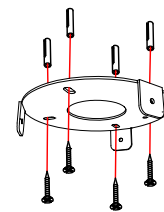

CE

- ② Connect the lamp to the main power using the connectors provided. You can also connect the dimmer if your electrical system has it.

Connettere la lampada all'impianto elettrico utilizzando i connettori forniti. Potete connettere anche il dimmer se l'impianto ne è fornito.

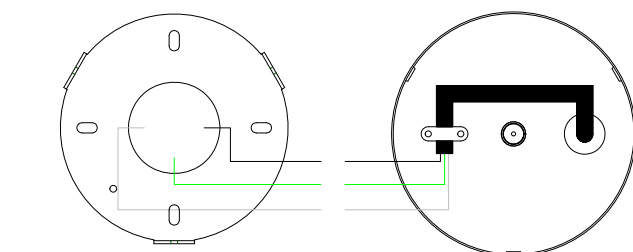

USA

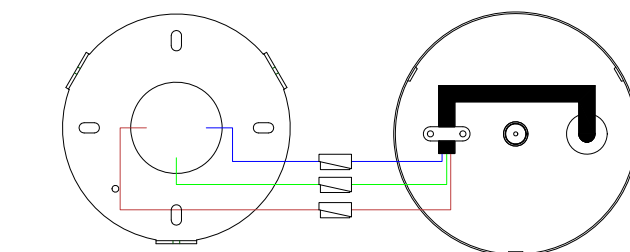

CE

- ③ Fix the canopy to the bracket with the screws provided and adjust the grade and height of the lamp using the steel cables.

Fissare il rosone alla staffa con le viti fornite e regolare l'inclinazione e l'altezza della lampada usando i cavi d'acciaio.

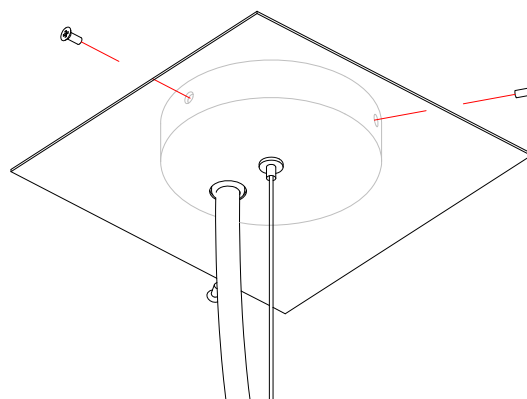

ALL OPERATIONS MUST BE CARRIED OUT BY QUALIFIED PERSON

- ④ Align the shade pivots with the central cross and unscrew the nuts.

Allineare i perni del telaio con la croce centrale e svitare i dadi.

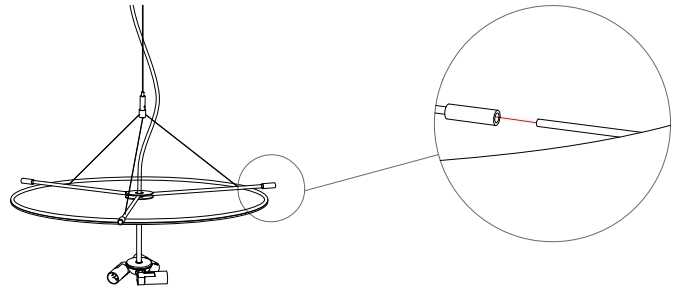

- ⑤ Insert the bulbs.

Inserire le lampadine.

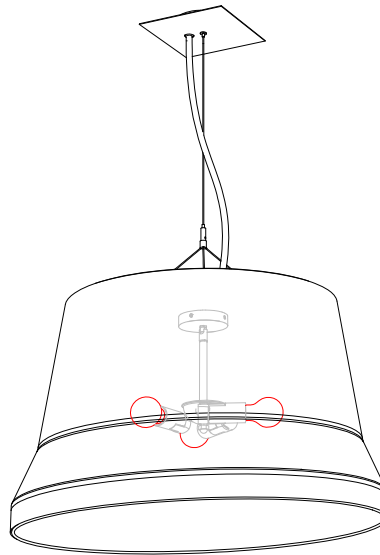

- ⑤ Insert the diffuser from the bottom of the shade.

Inserire il diffusore dalla parte inferiore del paralume.

