

ALL OPERATIONS MUST BE CARRIED OUT BY QUALIFIED PERSON

- ① Fix the bracket on the ceiling
(use appropriate anchors
depending on the type of ceiling).

Fissare la staffa a soffitto
(utilizzare tasselli appropriati
in base al tipo di soffitto).

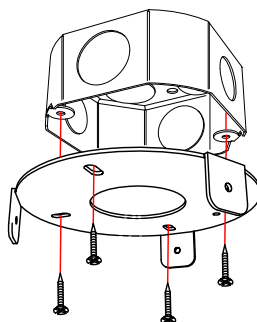

USA

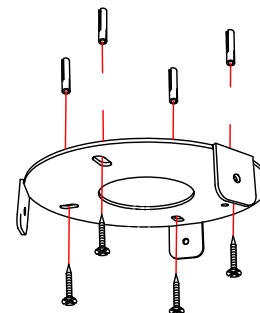

CE

- ② Complete the wiring as shown in the diagram.

Eseguire il cablaggio come mostrato nello schema.

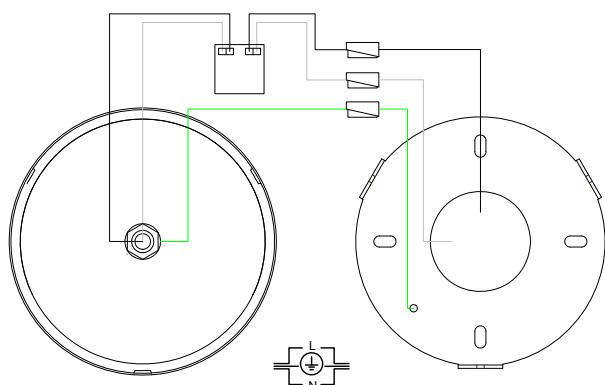

USA

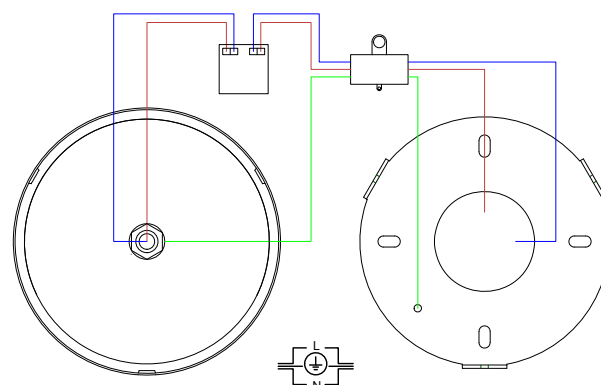

CE

ALL OPERATIONS MUST BE CARRIED OUT BY QUALIFIED PERSON

- ③ Loosen the grain of the pipe to adjust the height to which you want to place the accumulating lamp excess cable in the rose

 Allentare il grano del tubo per regolare l'altezza a cui si vuole posizionare la lampada accumulando nel rosone il cavo in eccesso.

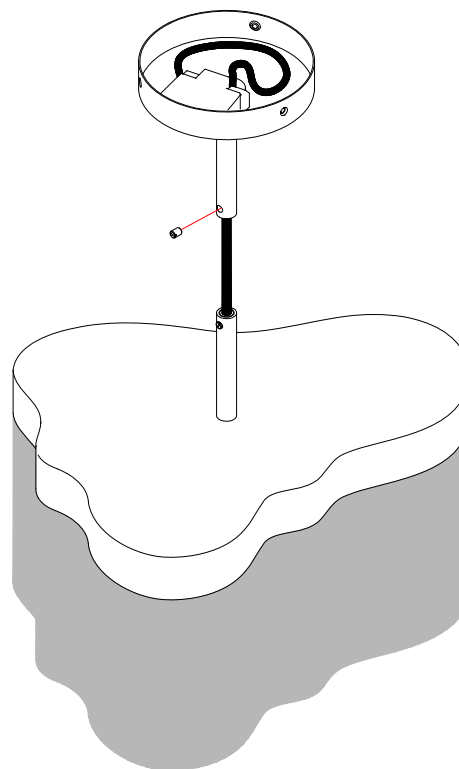

- ④ Once the height is adjusted, tighten the grain and the rosette to the plate through the screws supplied.

 Regolata l'altezza, stringere il grano e fissare il rosone alla piastra tramite le viti fornite.

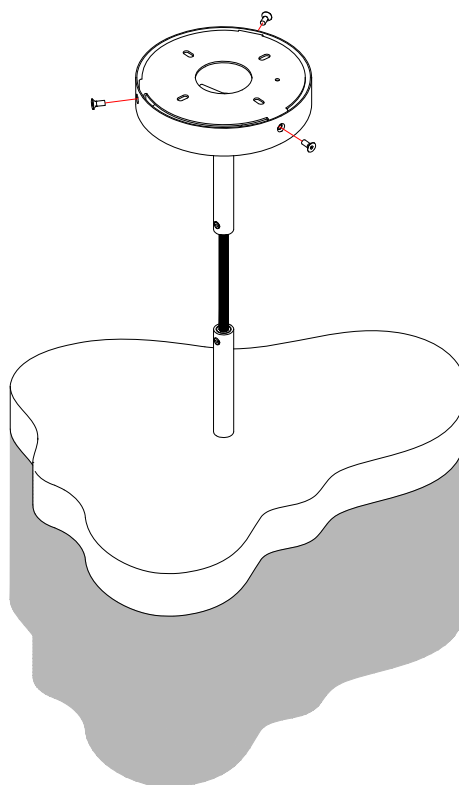

DC BMU - 12W 500mA



DRIVER - TRASFORMATORE

Pag. 1/1

DRAWN BY

N.O.

Direct current electronic drivers
Alimentatori elettronici in corrente continua

TCI LED Made in Italy

constant CURRENT constant VOLTAGE

IS 15885
(Part 2 / Sec 13)
S (7)
R - 41049751

DAMP LOCATION

UL-CLASS2
C RA US (3)
CSA-LVLE

EN EC 05

KEMA EUR

CCC

100

M M

EL SELV 60V

RIPPLE FREE

1+2kV DIFF. 2kV COMM.

SAFETY PROTECTIONS

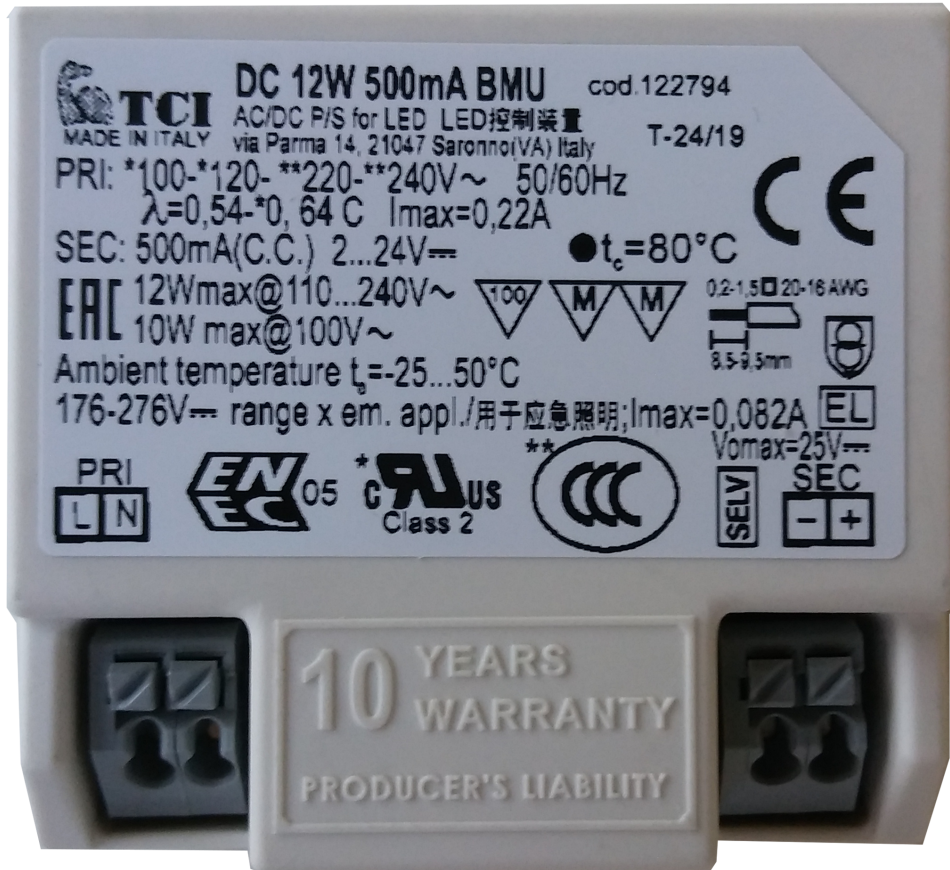

10 YEARS WARRANTY
PRODUCER'S LIABILITY

BUILT-IN

SCREW FIXING

Weight - Peso gr. 45 / 1,6 oz.
Pcs - Pezzi 70

WIRING DIAGRAM

