

ALL OPERATIONS MUST BE CARRIED OUT BY QUALIFIED PERSON

- ① Separate the ballast from the base by unscrewing the screws.

Separare la zavorra dalla base svitando le viti.

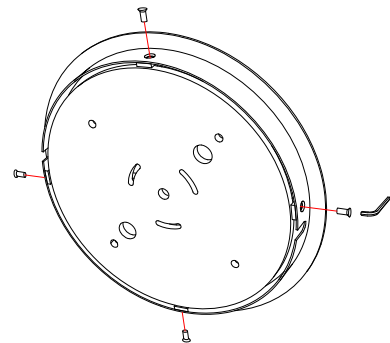

- ② Fix the lamp body to the base, matching the threaded pins to the holes and insert the cable through the hole of the base.

Fissare il corpo della lampada alla base, facendo corrispondere i perni filettati ai fori e facendo passare il cavo attraverso il foro della base.

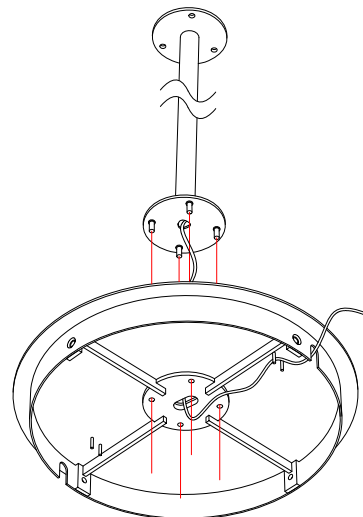

- ③ Secure the threaded pins with the nuts. Secure the cable using the supplied cable clamps.

Fissare i perni filettati tramite i dadi.  
Fissare il cavo tramite i fermacavi forniti.

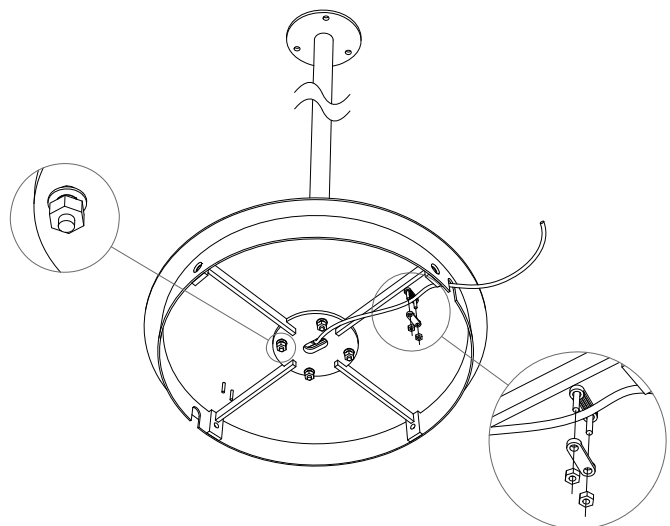

ALL OPERATIONS MUST BE CARRIED OUT BY QUALIFIED PERSON

- ④ Fix the ballast to the base using the screws provided.

-----  
Fissare la zavorra alla base tramite le viti fornite.

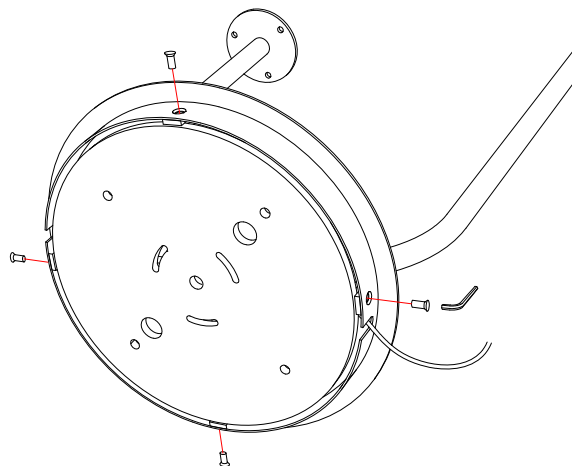
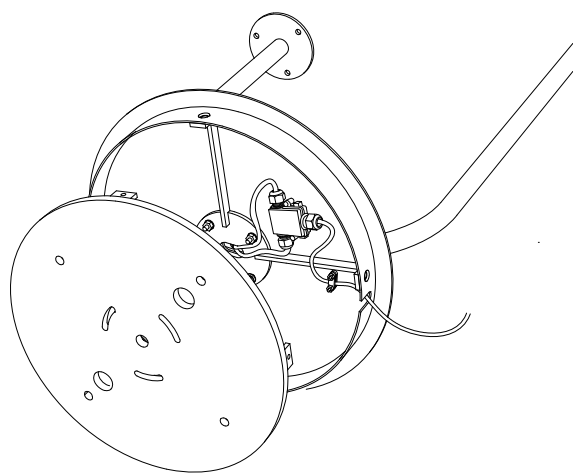

- ⑤ Set the glass on the bulbs.

-----  
Apporre il vetro sopra alle lampadine.

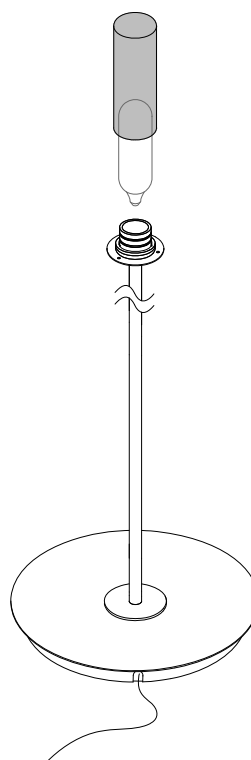

ALL OPERATIONS MUST BE CARRIED OUT BY QUALIFIED PERSON

- ⓘ During the assembly, or when replacing a bulb, verify the presence of the gasket (o-ring), between the ring nut and the glass.  
Insert the glass until insert it up to the bottom.  
Warning! Thread the glass by applying pressure and not rotating it.  
If the glass or the gasket are damaged, do not connect the power unit and replace them.

Nel montaggio o nella sostituzione della lampadina, verificare sempre la presenza della guarnizione (o-ring), tra ghiera e vetro.

Inserire il vetro fino ad infilarlo fino in fondo.

Attenzione! Infilare il vetro applicando una pressione e non ruotandolo.

Se il vetro o la guarnizione risultano danneggiati, non collegare l'alimentazione e sostituirli.

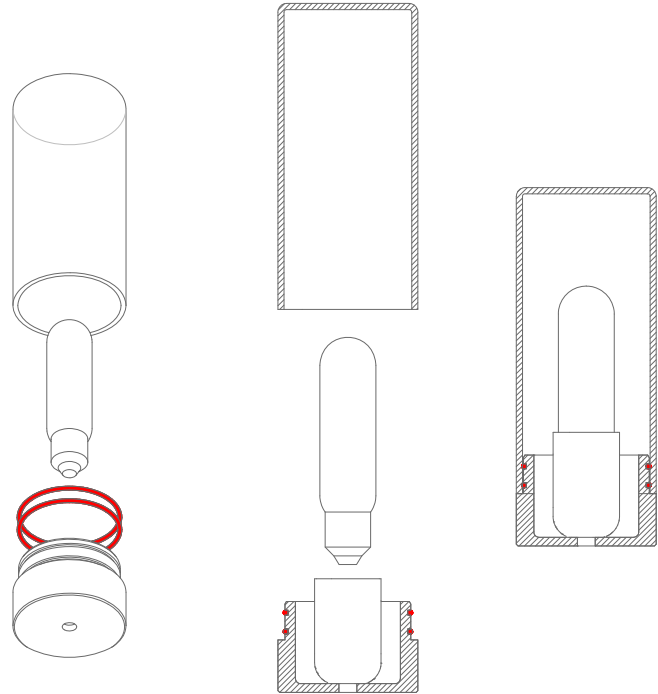

- ⑥ Fix the lampshades to the plates using the screws provided.

Fissare i paralumi ai piatti utilizzando le viti fornite.

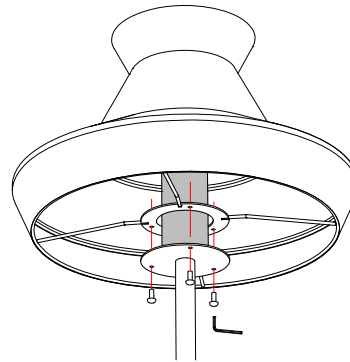

- ⑦ Connect the lamp cable to the IP 68 connector.

Collegare il cavo della lampada al connettore IP 68.

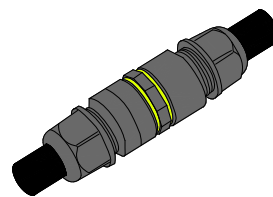

# M682-B IP68 Waterproof Connector

Connettore impermeabile M682-B IP68



INSTALLING INSTRUCTIONS

Pag. 1/2

DRAWN BY

N.O.

ALL OPERATIONS MUST BE CARRIED OUT BY QUALIFIED PERSON

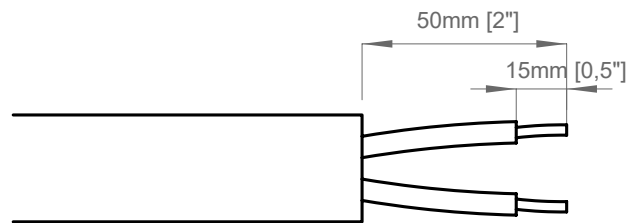
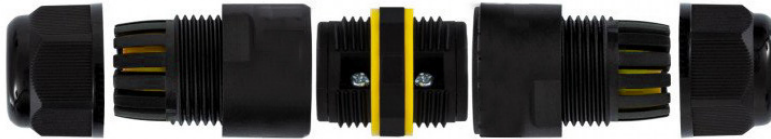

- ① Prepare terminal connector and two wires, wires need split 2" and remove 1/2" of jacket.

Preparare il connettore terminale e i due fili, i fili devono essere scoperti 50mm circa e rimuovere 15mm dal rivestimento dei cavi.

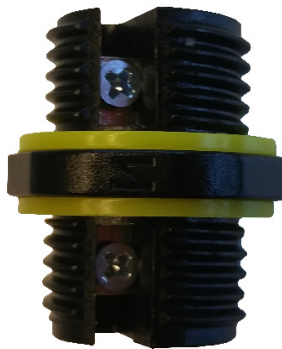

- ② Back out the screws in terminal block a little to ensure following easy connection.

Allentare leggermente le viti nella morsettiera per garantire una facile connessione.

# M682-B IP68 Waterproof Connector

Connettore impermeabile M682-B IP68



INSTALLING INSTRUCTIONS

Pag. 2/2

DRAWN BY

N.O.

ALL OPERATIONS MUST BE CARRIED OUT BY QUALIFIED PERSON



- ③ Plug the wires into the terminal block and screw tighten, please make sure the color of wires matches the picture.

-----  
Inserire i fili nella morsettiera e serrare a fondo, assicurarsi che il colore dei fili sia corrispondente all'immagine.



- ④ Twist and tighten the cable glands.

-----  
Serrare i fermacavi.