

# Kiki

CONTARDI STUDIO



# Kiki

CONTARDI STUDIO



**WITH CANOPY | WITHOUT CANOPY**  
SUSPENSION

**WALL | WALL CONNECT**  
WALL

TABLE

Kiki is a light with a pop and contemporary design, available in suspension, ceiling wall and table versions. Made of metal with elegant finishes, it offers a white opal glass diffuser for soft and even light. In its modular use, both in suspension and wall versions, it allows for great decorative opportunities, thanks to the different accessory and inputs that allow multiple configurations. Perfect for projects requiring creative and unexpected lighting solutions.

Kiki è una luce dal design pop e contemporaneo, in versioni a sospensione, plafone, a parete e da tavolo. Realizzata in metallo con eleganti finiture, offre un diffusore in vetro opale bianco per una luce morbida e uniforme. Nel suo utilizzo modulare sia a sospensione che a parete consente grandi opportunità decorative anche grazie ai diversi accessorio e ingressi che consentono molteplici configurazioni. Perfetta per progetti che richiedono soluzioni illuminotecniche creative e inaspettate.

- P3 **Kiki suspension with canopy**
- P4 **Kiki suspension without canopy**
- P5 **Kiki wall**
- P6 **Kiki wall connect**
- P7 **Kiki table**

KIKI SUSPENSION WITH CANOPY

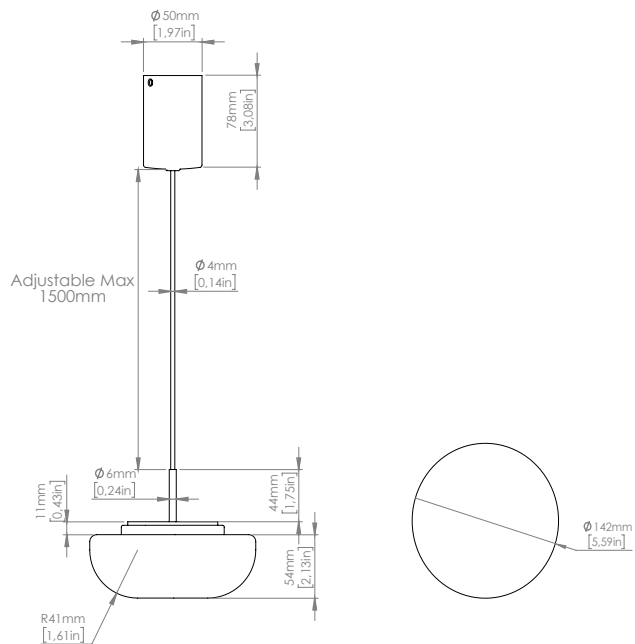

LIGHT EFFECT | EFFETTO LUMINOSO

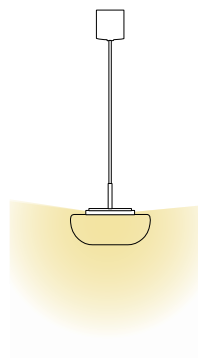

**LIGHT SOURCE | FONTE LUMINOSA**

220-240V · 110V | 1x5 W Custom LED  
550 Lm | 2.700 K | CRI >90

**DIMMING | DIMMERAZIONE**

Phase cut (Triac) | Taglio di fase  
DALI or 1-10V on demand | DALI o 1-10V su richiesta

**CABLE | CAVO**

Coaxial electrical cable | Cavo elettrico coassiale  
H.2000mm / 5000mm [78.7" / 196.8"]

**FINISHES | FINITURE**

METAL FRAME | STRUTTURA METALLICA

 Champagne  
Champagne

GLASS DIFFUSER | DIFFUSORE IN VETRO

 Satin opal  
Bianco opale

**Packaging | Imballi**

|                        |                                    |
|------------------------|------------------------------------|
| <b>DRIVER ON BOARD</b> | 220x220xh.200mm [8.6"x8.6"xh.7.8"] |
|                        | 1 kg [2.2 lbs]                     |

KIKI SUSPENSION WITHOUT CANOPY

LIGHT EFFECT | EFFETTO LUMINOSO

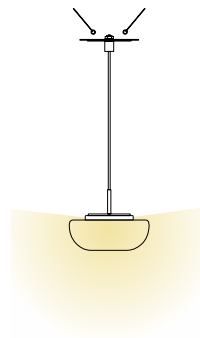
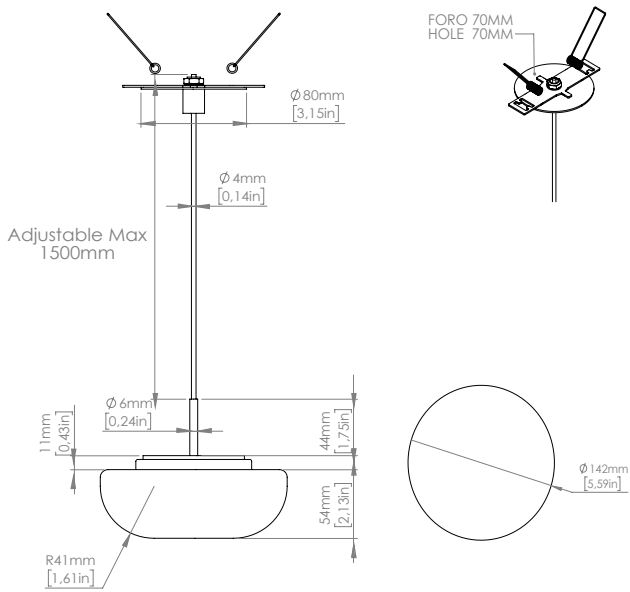

**LIGHT SOURCE | FONTE LUMINOSA**

220-240V · 110V | 1x5 W Custom LED  
550 Lm | 2.700 K | CRI >90

**DIMMING | DIMMERAZIONE**

Phase cut (Triac) | Taglio di fase  
DALI or 1-10V on demand | DALI o 1-10V su richiesta

**CABLE | CAVO**

Coaxial electrical cable | Cavo elettrico coassiale  
H.2000mm / 5000mm [78.7" / 196.8"]

**FINISHES | FINITURE**

METAL FRAME | STRUTTURA METALLICA

Champagne  
Champagne

GLASS DIFFUSER | DIFFUSORE IN VETRO

Satin opal  
Bianco opale

**Packaging | Imballi**

|                      |                                    |
|----------------------|------------------------------------|
| <b>REMOTE DRIVER</b> | 220x220xh.200mm [8.6"x8.6"xh.7.8"] |
|                      | 1 kg [2.2 lbs]                     |

WALL

LIGHT EFFECT | EFFETTO LUMINOSO

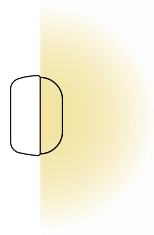
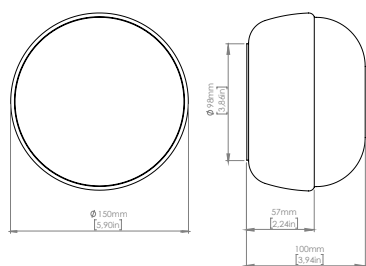

LIGHT SOURCE | FONTE LUMINOSA

220-240V · 110V | 1x5 W Custom LED  
550 Lm | 2.700 K | CRI >90

DIMMING | DIMMERAZIONE

Phase cut (Triac) | Taglio di fase  
DALI or 1-10V on demand | DALI o 1-10V su richiesta

FINISHES | FINITURE

METAL FRAME | STRUTTURA METALLICA

-  Brushed bronze-nickel  
Bronzo-nickel spazzolato
-  Champagne  
Champagne

GLASS DIFFUSER | DIFFUSORE IN VETRO

-  Satin opal  
Bianco opale

Packaging | Imballi

|             |                                    |
|-------------|------------------------------------|
| <b>WALL</b> | 220x200xh.200mm [8.6"x7.8"xh.7.8"] |
|             | 1 kg [2.2 lbs]                     |

WALL CONNECT

LIGHT EFFECT | EFFETTO LUMINOSO

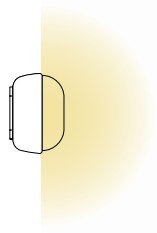
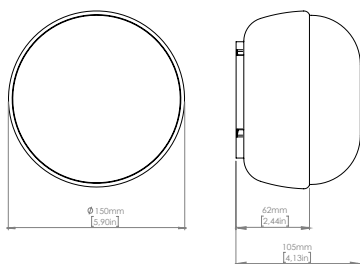

**LIGHT SOURCE | FONTE LUMINOSA**

220-240V · 110V | 1x5 W Custom LED  
550 Lm | 2.700 K | CRI >90

**DIMMING | DIMMERAZIONE**

Phase cut (Triac) | Taglio di fase  
DALI or 1-10V on demand | DALI o 1-10V su richiesta

**FINISHES | FINITURE**

METAL FRAME | STRUTTURA METALLICA

-  Brushed bronze-nickel  
Bronzo-nickel spazzolato
-  Champagne  
Champagne

GLASS DIFFUSER | DIFFUSORE IN VETRO

-  Satin opal  
Bianco opale

**Packaging | Imballi**

|                |                                    |
|----------------|------------------------------------|
| <b>CONNECT</b> | 220x200xh.200mm [8.6"x7.8"xh.7.8"] |
|                | 1 kg [2.2 lbs]                     |

TABLE

LIGHT EFFECT | EFFETTO LUMINOSO

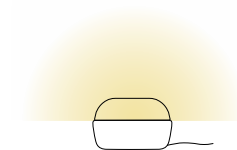
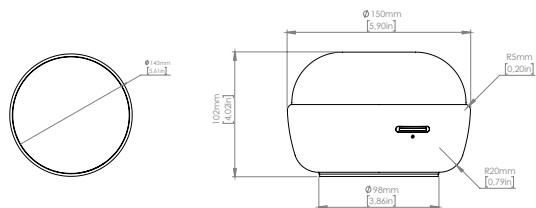

**LIGHT SOURCE | FONTE LUMINOSA**

220-240V · 110V | 1x5 W Custom LED  
550 Lm | 2.700 K | CRI >90

**DIMMING | DIMMERAZIONE**

Dimmer on board | Dimmer a bordo

**CABLE | CAVO**

Dark brown fabric | Tessuto marrone testa di moro  
L.2000mm [78.7"]

**FINISHES | FINITURE**

METAL FRAME | STRUTTURA METALLICA

-  Brushed bronze-nickel  
Bronzo-nickel spazzolato
-  Champagne  
Champagne

GLASS DIFFUSER | DIFFUSORE IN VETRO

-  Satin opal  
Bianco opale

**Packaging | Imballi**

|              |                                    |
|--------------|------------------------------------|
| <b>TABLE</b> | 220x200xh.200mm [8.6"x7.8"xh.7.8"] |
|              | 1 kg [2.2 lbs]                     |



**CONTARDI LIGHTING Srl**

ITALY HEADQUARTERS  
[contardi-italia.com](http://contardi-italia.com)

**CONTARDI USA Inc**

USA BRANCH  
[contardi-usa.com](http://contardi-usa.com)

Copyright and/or design rights subsist in this drawing. No part of this drawing may be reproduced in any material form (including photocopying or storing in any medium electronic means, whether or not intentionally and whether or not as part or a larger publication) without the express permission of the copyright owner, Contardi Lighting S.r.l.. Further and without prejudice to the above, this drawing and all information relating thereto is confidential, and shall not be communicated to a third party without the consent of Contardi lighting srl. Contardi Lighting Srl asserts all rights to be identified as the author of the work and otherwise.

WARNING: The doing of any unauthorised act in relation to a copyright work may result in both a civil claim for damages and criminal prosecution.